

Pre-assembled and pre-cabled in different aperture to highlight the processes

# LED Signal Towers

- Modular and monolithic design are available.
- Patlite's extensive product range cover highly advanced LED signal towers for industrial automation and security applications.
- Mechanical and electrical durability is a key feature of signal towers since machine operators rely on the signals they show. LED modules together with an impact and heat resistant ABS resin housing are the elements to give clear guidance of the operator for a long service life.
- Different aperture for different application (from 30 mm till 70 mm)
- This signal towers are designed for use in different environments till a protection up to IP 65. That makes them suitable for the widest possible range of applications in general industries.

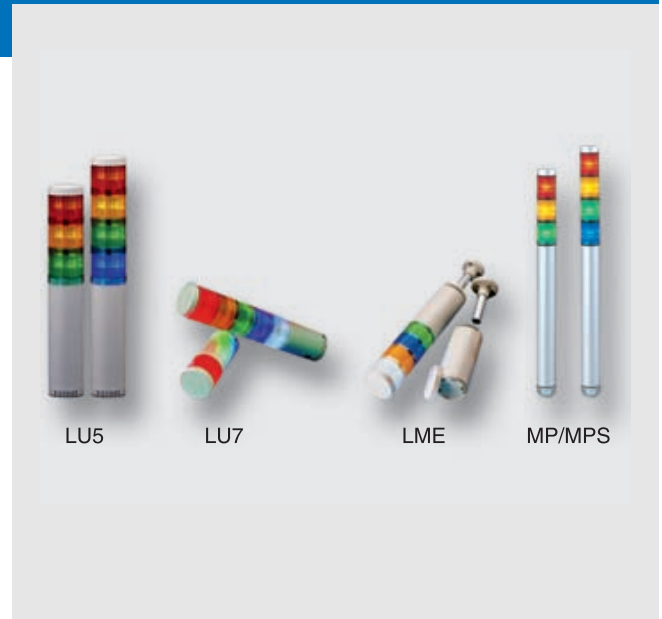

## Features/Unique selling proposition

### Modular system:

**LU5 & LU7** series signal towers deliver the advantages of superior LED technology, innovative design, and the convenience of modular assembly with only 9 basic modular components to meet just about every indicating need.



**LU5/LU7:** Versatile modular Signal Tower featuring easy assembly and wiring designed for every need.

### Monolithic system:

**MP/MPS:** Super slim 30 mm Signal tower ideal for small and mid-sized machines with a special pre-wired versatile 1 m connection cable.



**LME:** Versatile, cost and energy efficient LED Signal tower for every need and a special pre-wired versatile and flexible cable connection of 3 m.

## LU5

### Nomenclature/How to order

LED module

LU5-E-R  
1 2

1. E: LED unit
2. Color of LED
  - R: Red
  - Y: Yellow
  - G: Green
  - B: Blue
  - C: Clear/White

Base module

LU5-02UFB  
1 2 3

1. Rated voltage
  - 02: 24 VDC
2. Unit color
  - Blank: Ivory white
  - U: Silver color
3. Type
  - Blank: Continuous light
  - FB: Continuous or flashing light with audible alarm

### Ordering Information

#### LED module

Module Color	Power Consumption	Rated Voltage	Operation Voltage	Operation Temperature Range	Mass	Order Code
Red	52 mA/1.25 W	24 VDC	Rated voltage ±10% (21.6~26.4 V)	-30°C~+60°C	44 g ±10%	LU5-E-R
Yellow						LU5-E-Y
Green	42 mA/1.0 W					LU5-E-G
Blue						LU5-E-B
Clear						LU5-E-C

#### Base module

Typ	Alarm/ Flash	Power Consumption	Rated Voltage	Operation Voltage	Operation Temperature Range	Mass	Open Collector	Order Code
Standard Body	Continuous	1.2 W	24 VDC	Rated voltage ±10% (21.6 ~ 26.4 V)	-30°C~+60°C	182g ±10%	PNP/ NPN	LU5-02*
	2 Sounds/ Flash-light					200g ±10%		LU5-02FB*

\* Ivory white: black, silver: add "U"

#### Optional parts

Typ	Material	Order code
Wall Mount Bracket	Aluminum alloy die-cast	SZ-017
	ABS resin	SZ-020
Upper Bracket	Metal	SZ-60NPT
		SZ-60U
Mount Bracket	Aluminum alloy die-cast	SZ-016A
		SZ-70B

Typ	Height	Material	Order code
Pole	100 mm	Aluminium	Pole-100A21
	300 mm	Aluminium	Pole-300A21
	800 mm	Aluminium	Pole-800A21

#### Features



LED module is stackable and reconfigurable even after installation  
 IP 65: Implemented O rings seal out liquids so that the tower can be used in wet conditions.

Dimensions

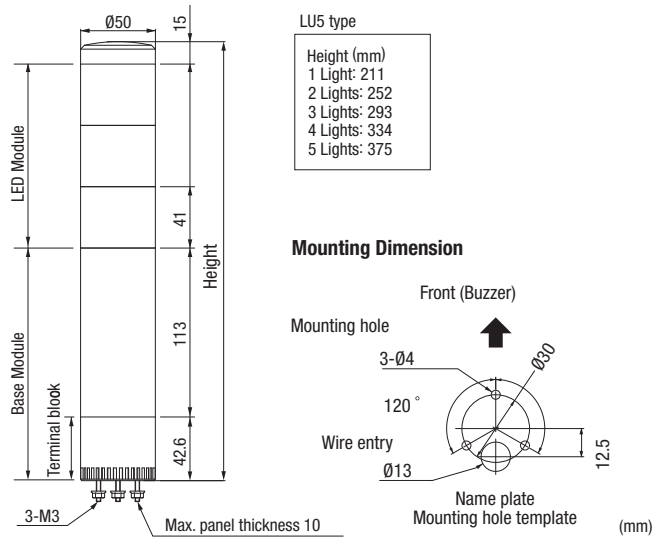

Wiring diagram



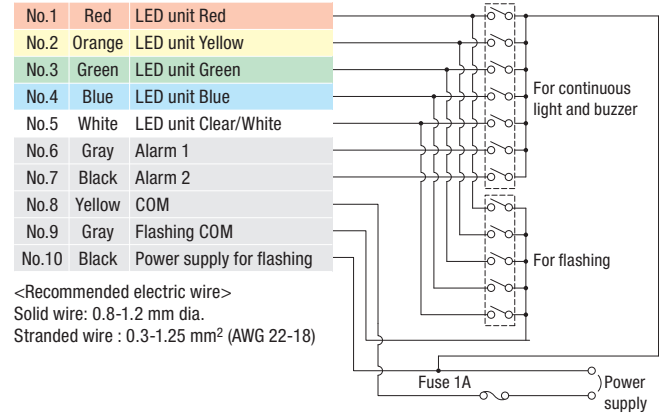

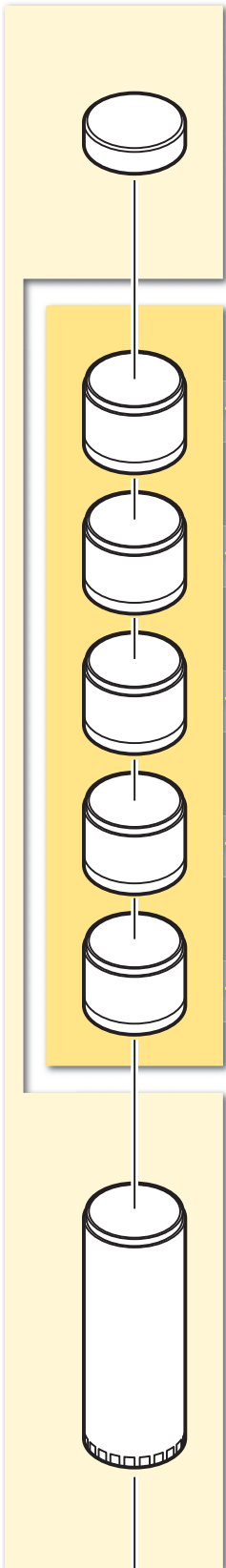
LU5-02FB  
24 VDC











### LED Units





<b>Model</b>	LU5-E-R	LU5-E-Y	LU5-E-G	LU5-E-B	LU5-E-C
<b>Unit Color</b>					
<b>Rated Voltage</b>	24 VDC				
<b>Operating Voltage Range</b>	Rated Voltage±10%(21.6~26.4 V)				
<b>Current/Power Consumption</b>	52 mA/1.25 W		42 mA/1.0 W		
<b>Operating Temperature Range</b>	-30°C~+60°C				
<b>Mass</b>	44 g±10%				



 RED
 YELLOW
 GREEN
 BLUE
 CLEAR/WHITE

### BASE Units



<b>Model</b>	LU5-02	LU5-02FB
<b>Color</b>		
<b>Standard Body/Short Body</b>	Standard	
<b>Rated Voltage</b>	24 VDC	
<b>Operating Voltage Range</b>	Rated voltage±10%(21.6~26.4 V)	
<b>Buzzer</b>	-	*Buzzer 1    **Buzzer 2
<b>Current Consumption</b>	-	50±10 mA    24±10 mA
<b>Power Consumption</b>	-	1.2±0.25 W    0.58±0.25 W
<b>Sound Level</b>	-	Max:85±5dB(at 1m)
<b>Flashing Cycle</b>	-	6±12 flashes per minutes
<b>Operating Temperature</b>	-30°C~+60°C	
<b>Range</b>	Upright, Indoor only	
<b>Mounting Direction</b>	IP65	
<b>Protection Rating</b>	182 g±10%	200 g±10%
<b>Mass</b>	PNP/NPN	

**Open Collector**  
 \* Buzzer 1 : Continuous Sound    \*\*Buzzer 2 : Intermittent Sound

 Ivory White
 Silver Color(U)

Optional Parts

How to order

Optional Parts

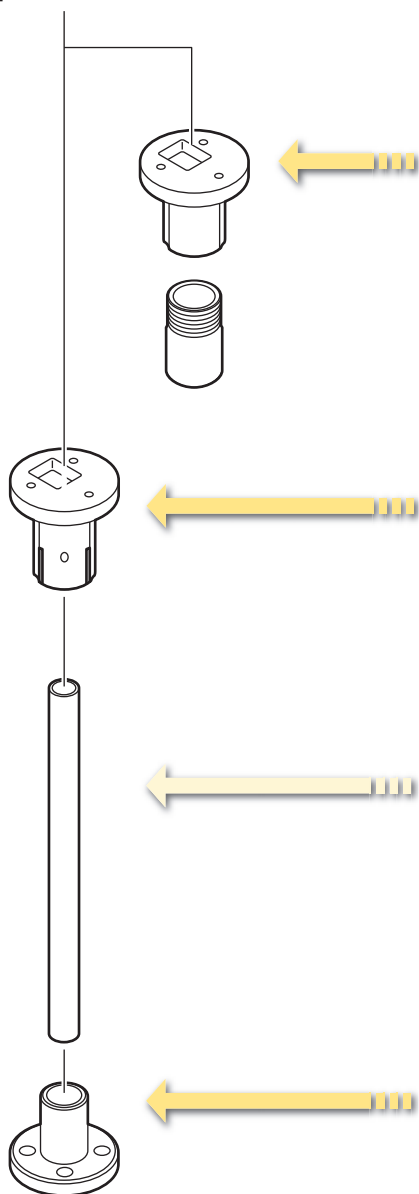

**Upper Bracket**

SZ-60NPT (for 1/2" NPT Pole)

**Upper Bracket**

SZ-60-U

**Pole**

21.7mm

**Steel Pole**

<b>Model</b>	POLE-800S21	POLE-300S21	POLE-100S21
<b>Height</b>	800mm	300mm	100mm

**Aluminum Pole**

<b>Model</b>	POLE-800A21	POLE-300A21	POLE-100A21
<b>Height</b>	800mm	300mm	100mm

**Mount Bracket**

SZ-016A  
(For Ø21.7mm Pole)

SZ-70-B  
(For Ø21.7mm Aluminium Pole Only)

**Wall Mount Bracket**

SZ-020  
(For Ø21.7mm Pole)

SZ-017  
(For Ø21.7mm Pole)

Specifications

Size	50 mm diameter
Input voltage options	24 VDC
Functions available	Continuous only Continuous, Flashing, Alarms
Mounting options	Direct mount only, includes 3 mounting nuts
Body styles	Component style, wiring terminals provided Interchangeable and stackable after purchase
Body colours	Beige
Tiers	1-5 modules can be stacked
Module colors	Red / Yellow / Green / Blue / Clear
Alarms (FB style only)	Alarm 1: selectable, single-tone, continuous alarm, 85 dB (at 1 m) Alarm 2: selectable, single tone, intermittent (slow beep) alarm, 85 dB (at 1 m)
Ratings	CE UL Listed (US) UL Listed (Canada) RoHS
Protection	IP-65 Type 4 / 4X / 13 (indoor only)
Control options	Dry contact closure such as switches or relay contacts Open-collector transistor (NPN or PNP) for 24 VDC Direct voltage control for 24 VDC, continuous and alarm functions only

LU7

Ordering Information

LED module

Typ	Module Color	Power Consumption	Rated Voltage	Operation Voltage	Operation Temperature Range	Mass	Order Code	
Standard	Red	52 mA/ 1.25 W	24 VDC	Rated voltage±10% (21.6~26.4 V)	-30°C~+60°C	60 g ±10%	LU7-E-R	
	Yellow						LU7-E-Y	
	Green	42 mA/1.0 W					LU7-E-G	
	Blue						LU7-E-B	
	Clear/ White						LU7-E-C	
Strobe	Red	290 mA	24 VDC	Rated voltage±10% (21.6~26.4 V)	-30°C~+60°C	70 g	LU7-XE-R	
	Yellow	140 mA					LU7-XE-Y	
	Green						LU7-XE-G	
	Blue						270 mA	LU7-XE-B
	Clear/ White						280 mA	LU7-XE-C

Base module

Typ	Alarm/ Flash	Power Consumption	Rated Voltage	Operation Voltage	Operation Temperature Range	Mass	Open Collector	Order Code
Short Body	Continuous	1.2 W	24 VDC	Rated voltage ± 10% (21.6~26.4 V)	-30°C~+60°C	150 g ±10%	PNP/ NPN	LU7-02S*
Standard Body	Continuous					250 g ±10%		LU7 - 02*
	2 Sounds/ Flashlight					280 g ±10%		LU7 -02FB*

\* Ivory white: blank, black: add "K", silver: add "U"

Optional parts

Typ	Material	Order code
Wall Mount Bracket	Aluminum alloy die-cast	SZ-017
	PBT/ ABS resin	SZ-018
		SZ-018U
		SZ-018K
	ABS resin	SZ-020
Upper Bracket	Metal	SZ - 50U
		SZ - 50UU
		SZ - 50KU
		SZ - 50NPT
Mount Bracket	Aluminum alloy die-cast	SZ-016A
		SZ-70B

Typ	Height	Material	Order code
Pole	100 mm	Aluminium	Pole-100A21
		Steel	Pole-100S21
	300 mm	Aluminium	Pole-300A21
		Steel	Pole-300S21
	800 mm	Aluminium	Pole-800A21
		Steel	Pole-800S21

Voice and Sound Module  
(unique sound module in all directions)

Rated Voltage	Power Consumption	Mass	Order code
24 VDC	3.5 W	170 g	LU7-V1

Features

Easy alignment:  
Color-coordinated Terminal Block:  
Corresponds to the lens colors for quick wiring verification in the base unit.

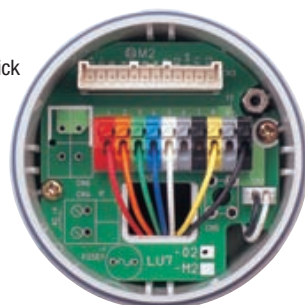

LU7-02FB

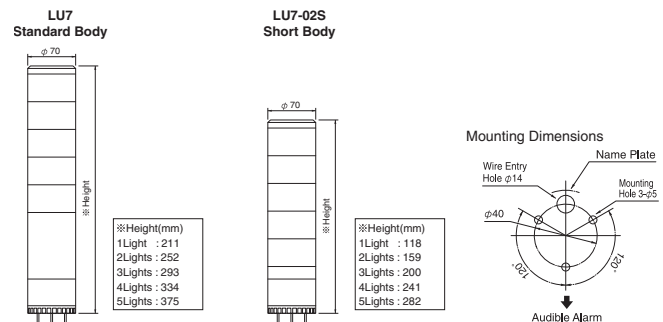

How to order

### Voice and Sound Module

Model	LU7-V1				
Type	Voice Synthesizer				
Rated Voltage	24 VDC				
Power Consumption	3.5 W				
Weight	0.17 kg				

### LED Units

Model	LU7-E-R	LU7-E-Y	LU7-E-G	LU7-E-B	LU7-E-C
Unit Color	●	●	●	●	○
Rated Voltage	24 VDC				
Operating Voltage Range	Rated Voltage±10%(21.6~26.4 V)				
Current/Power Consumption	52 mA/1.25 W		42 mA/1.0 W		
Operating Temperature Range	-30°C~+60°C				
Mass	60 g±10%				

### LED Strobe Module

Model	LU7-XE-R	LU7-XE-Y	LU7-XE-G	LU7-XE-B	LU7-XE-C
Unit Color	●	●	●	●	○
Rated Voltage	24 VDC				
Power Consumption	290 mA	290 mA	140 mA	270 mA	280 mA
Mass	0.07 kg				

RED
  YELLOW
  GREEN
  BLUE
  CLEAR/WHITE

### BASE Units

**Standard Body**

**Short Body**

Model	LU7-02S	LU7-02	LU7-02FB
Color		○ ● ●	
Standard Body/Short Body	Short	Standard	
Rated Voltage	24 VDC		
Operating Voltage Range	Rated voltage±10%(21.6~26.4 V)		
Buzzer	-	*Buzzer 1 : **Buzzer 2	
Current Consumption	-	50±10 mA ; 24±10 mA	
Power Consumption	-	1.2±0.25 W ; 0.58±0.25 W	
Sound Level	-	Max:90±5dB(at 1m) Min:70dB or Less(at 1m)	
Flashing Cycle	-	60±12 flashes per minute	
Operating Temperature	-30°C~+60°C		
Range	Upright, Indoor only		
Mounting Direction	IP65		
Protection Rating Mass	150 g±10%	250 g±10%	280 g±10%
Open Collector	PNP/NPN		

\* Buzzer 1 : Continuous Sound    \*\*Buzzer 2 : Intermittent Sound

Ivory White
  Silver Color(U)
  Black(K)

**Optional Parts**



Optional Parts

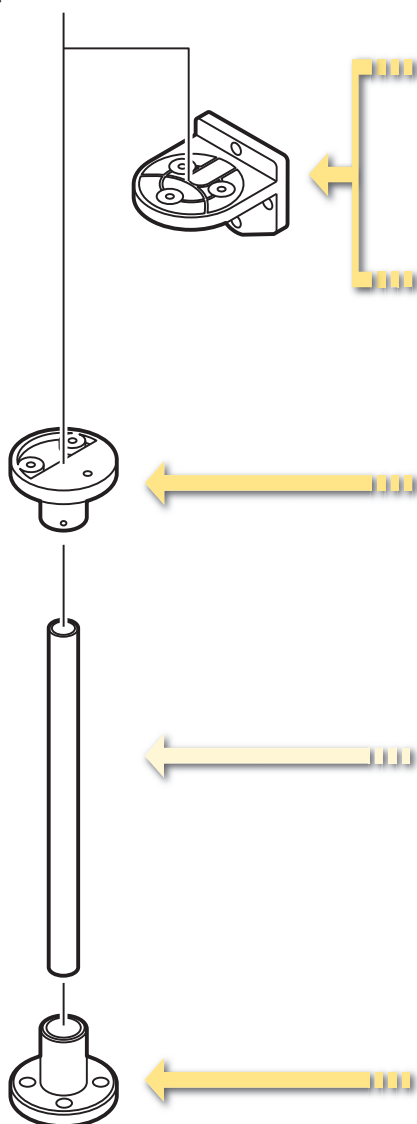

Wall Mount Bracket

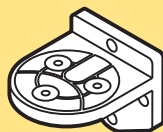

<b>Model</b>	SZ-18	SZ-18U	SZ-18K
<b>Color</b>	Ivory White	Silver Color (U)	Black (K)

Upper Bracket



SZ-50NPT (For 1/2" NPT Pole)

Upper Bracket



<b>Model</b>	SZ-50-U	SZ-50U-U	SZ-50K-U
<b>Color</b>	Ivory White	Silver Color (U)	Black (K)

Pole

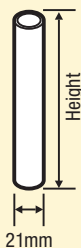

Steel Pole

<b>Model</b>	POLE-800S21	POLE-300S21	POLE-100S21
<b>Height</b>	800mm	300mm	100mm

Aluminum Pole

<b>Model</b>	POLE-800A21	POLE-300A21	POLE-100A21
<b>Height</b>	800mm	300mm	100mm

Mount Bracket

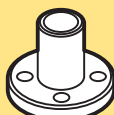

SZ-016A  
(For Ø21.7mm Pole)



SZ-70-B  
(For Ø21.7mm Aluminium Pole Only)

Wall Mount Bracket



SZ-020  
(For Ø21.7mm Pole)



SZ-017  
(For Ø21.7mm Pole)

Specifications

Size	70 mm diameter
Input voltage options	24 VDC
Functions available	Continuous only Continuous, Flashing, Alarms
Mounting options	Direct mount only; includes three mounting nuts
Body style	Component Style, wiring terminals provided Interchangeable and stackable after purchase
Body color	Beige Black Silver
Tiers	1-5 modules can be stacked
Module colors	Red / Yellow / Green / Blue / Clear Standard LED Modules Strobe-flash LED Modules (24 V bases only)
Alarms (FB style only)	Alarm 1: selectable, single-tone, continuous alarm, 90 dB (at 1 m) Alarm 2: selectable, single tone, intermittent (slow beep) alarm, 90 dB (at 1 m)
Ratings	CE UL Listed (US) UL Listed (Canada) RoHS
Protections	IP-65 Type 4/4X/13 (indoor only)
Control options	Dry contact closure such as switches or relay contacts Open-collector transistor (NPN or PNP) for 24 VDC Direct voltage control for 24 VDC, continuous and alarm functions only

MP/MPS

Nomenclatur/ How to order:

MP-502-RYGBC-B0438

- |   |  |   |
|---|--|---|
| 1. MP: Standard Body<br>MPS: Short Body | 4. Color of LED<br>R: Red<br>Y: Yellow<br>G: Green<br>B: Blue<br>C: Clear/White<br>Top to bottom | 5. Color of lense<br>Blank: Colored lens<br>B0438: Clear lens |
|---|--|---|

Ordering information

Number of stacks	Rated voltage	Power Consumption	Open collector	Order code
1	24 VAC/ VDC	0.7 W	NPN/PNP	MP/MPS-102
2		1.4 W		MP/MPS-202
3		2.0 W		MP/MPS-302
4		2.6 W		MP/MPS-402
5		3.2 W		MP/MPS-502

Features

Patented reflection system increases visibility.

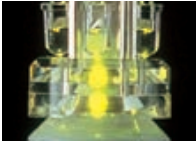

High intensity LED



Good visibility from any direction

Interchangeable LED modules

- Changeable color sequence: Easy to add/remove up to 5 colored modules even after installation.
- Note: LED modules of the same color will light up simultaneously.

The wiring remains the same.

Each color of LED module corresponds to the lead wire color.



Dimensions

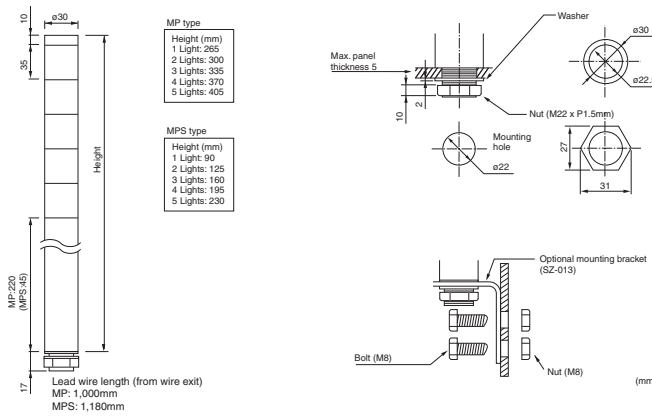

Wiring diagram

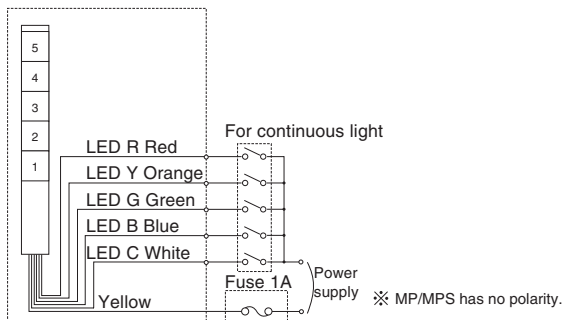

Specifications

Size	30 mm diameter
Input voltage options	24 VAC/VDC
Functions available	Continuous only
Mounting options	Direct mount only: includes M22 mounting nut and sealing gasket
Body style	pre-assembled, pre-wired Interchangeable and stackable after purchase
Body color	Silver
Tiers	1-5 modules can be stacked
Module colors	Red / Yellow / Green / Blue / Clear-White (for sunlight applications: clear-lense modules in all colors available)
Ratings	CE UL Component Recognition (US) UL Component Recognition (Canada) RoHS
Protection	IP-65
Control options	Dry contact closure such as switches or relay contacts Open-collector transistor (NPN or PNP) for 24 VDC Direct voltage control

LME

Nomenclature/How to order

LME-502UFBW-C-RYGBC-Z

1 2 3 4 5 6 7

- 1. Stack  
1 ~ 5
- 2. Rated Voltage  
02: 24V AC/DC
- 3. Body Color  
Blank: Ivory white  
N: Black color  
U: Silver color
- 4. Type  
Blank: Continuous light  
FB: Continuous light or flashing light with audible alarm
- 5. Mount  
Blank: Pole mount  
K: Pole Mount (with SZ-020)  
W: Direct mount
- 6. Cable  
C: Special pre-wired cable connection of 3 m
- 7. Color of LED  
R: Red  
Y: Yellow  
G: Green  
B: Blue  
C: Clear/White
- 8. Color of Lens  
Blank: Colored lens  
Z: Clear lens

Ordering Information

Number of Stacks	Mount	Model	Rated Voltage	Power Consumption	Open Collector	Order code	
						Continuous light	Continuous light with audible alarm
1	Pole Mount	LME-102	24 VAC/DC	2.2 W	NPN/ PNP	LME-102-C	LME-102-FB-C
	Direct Mount		24 VAC/DC			LME-102W-C	LME-102-FBW-C
2	Pole Mount	LME-202	24 VAC/DC	3.4 W		LME-202-C	LME-202-FB-C
	Direct Mount		24 VAC/DC			LME-202W-C	LME-202-FBW-C
3	Pole Mount	LME-302	24 VAC/DC	3.8 W		LME-302-C	LME-302-FB-C
	Direct Mount		24 VAC/DC			LME-302W-C	LME-302-FBW-C
4	Pole Mount	LME-402	24 VAC/DC	4.2 W		LME-402-C	LME-402-FB-C
	Direct Mount		24 VAC/DC			LME-402W-C	LME-402-FBW-C
5	Pole Mount	LME-502	24 VAC/DC	4.6 W		LME-502-C	LME-502-FB-C
	Direct Mount		24 VAC/DC			LME-502W-C	LME-502-FBW-C

Optional parts

Typ	Material	Order code
Wall Mount Bracket	Aluminum alloy die-cast	SZ-017
	ABS resin	SZ-020
	PBT/ ABS resin	SZ-028
Mount Bracket	Aluminum alloy die-cast	SZ-016A
	Aluminum alloy die-cast	SZ-010

Typ	Height	Material	Order code
Pole	100 mm	Aluminium	Pole-100A21
		Steel	Pole-100S21
	300 mm	Aluminium	Pole-300A21
		Steel	Pole-300S21
	800 mm	Aluminium	Pole-800A21
		Steel	Pole-800S21

Dimensions

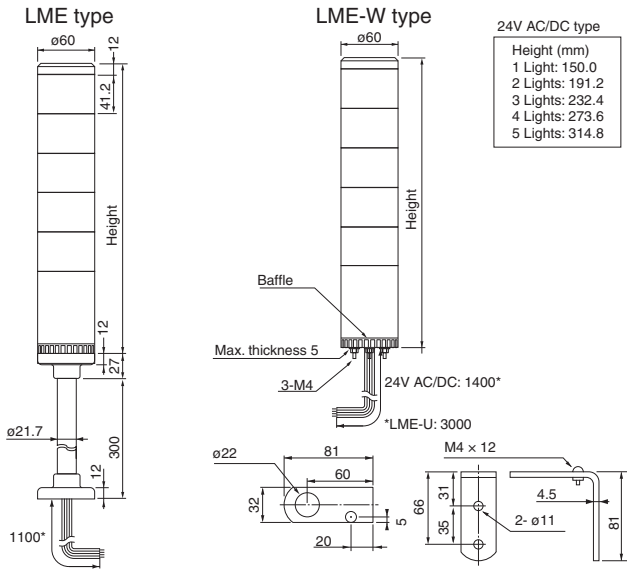

Wiring diagram

LME(-W)/LME(-W)-S-Q/LMS [Continuous type]

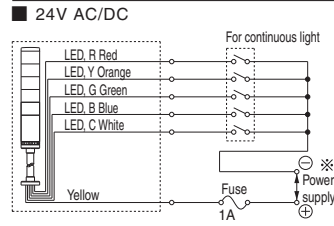

Features

Interchangeable LED modules

- Changeable color sequence: Easy to add / remove up to 5 colored modules even after installation.
- Note: LED modules of the same color within a signal tower will light up simultaneously.



Easy to add and remove

If the number of LED module is changed, center shaft must be purchased.

The wiring remains the same

Each color of LED module corresponds to the lead wire color.

Dual reflection system



PATLITE's original dual reflection system with its exclusive hybrid prism-cut lens and 5 color LED modules create bright, distinctive, even illumination.



To bring more attention to certain conditions, two, User-selectable, Alarms integrated in the Base module with adjustable volume up to 85 dB at 1m are available.

Specifications

Size	60 mm diameter
Input voltage options	24 VAC/VDC
Functions available	Continuous only Continuous, Flashing, Alarms
Mounting options	Pole mount: with 300 mm aluminum pole, plastic circular bracket Direct mount: includes 3 mounting nuts
Body style	Pre-assembled, pre-wired Interchangeable and stackable after purchase
Body color	Beige (optional: Black or Silver)
Tiers	1-5 modules can be stacked
Module colors	Red / Yellow / Green / Blue / Clear/White (for sunlight applications: clear-lense modules in all colors available)
Alarms (FB style only)	Alarm 1: selectable, single-tone, intermittent (fast beep) alarm, 85 dB (at 1 m) Alarm 2: selectable, single tone, intermittent (slow beep) alarm, 85 dB (at 1 m)
Ratings	CE UL Component Recognition (US) UL Component Recognition (Canada) RoHS
Protection	IP-65 (LME, LME-W) IP-54 (LME-FB, LME-FBW) Type 4/4X/13 (indoor, direct-mount only)
Control options	Dry contact closure such as switches or relay contacts Open-collector transistor (NPN or PNP) for 24 VDC Direct voltage control for 24 VDC, continuous and alarm functions only

---

**WARRANTY**

---

OMRON's exclusive warranty is that the products are free from defects in materials and workmanship for a period of one year (or other period if specified) from date of sale by OMRON.

OMRON MAKES NO WARRANTY OR REPRESENTATION, EXPRESS OR IMPLIED, REGARDING NON-INFRINGEMENT, MERCHANTABILITY, OR FITNESS FOR PARTICULAR PURPOSE OF THE PRODUCTS. ANY BUYER OR USER ACKNOWLEDGES THAT THE BUYER OR USER ALONE HAS DETERMINED THAT THE PRODUCTS WILL SUITABLY MEET THE REQUIREMENTS OF THEIR INTENDED USE. OMRON DISCLAIMS ALL OTHER WARRANTIES, EXPRESS OR IMPLIED.

**LIMITATIONS OF LIABILITY**

---

OMRON SHALL NOT BE RESPONSIBLE FOR SPECIAL, INDIRECT, OR CONSEQUENTIAL DAMAGES, LOSS OF PROFITS OR COMMERCIAL LOSS IN ANY WAY CONNECTED WITH THE PRODUCTS, WHETHER SUCH CLAIM IS BASED ON CONTRACT, WARRANTY, NEGLIGENCE, OR STRICT LIABILITY.

In no event shall responsibility of OMRON for any act exceed the individual price of the product on which liability is asserted.

IN NO EVENT SHALL OMRON BE RESPONSIBLE FOR WARRANTY, REPAIR, OR OTHER CLAIMS REGARDING THE PRODUCTS UNLESS OMRON'S ANALYSIS CONFIRMS THAT THE PRODUCTS WERE PROPERLY HANDLED, STORED, INSTALLED, AND MAINTAINED AND NOT SUBJECT TO CONTAMINATION, ABUSE, MISUSE, OR INAPPROPRIATE MODIFICATION OR REPAIR.

**SUITABILITY FOR USE**

---

THE PRODUCTS CONTAINED IN THIS DOCUMENT ARE NOT SAFETY RATED. THEY ARE NOT DESIGNED OR RATED FOR ENSURING SAFETY OF PERSONS, AND SHOULD NOT BE RELIED UPON AS A SAFETY COMPONENT OR PROTECTIVE DEVICE FOR SUCH PURPOSES. Please refer to separate catalogs for OMRON's safety rated products.

OMRON shall not be responsible for conformity with any standards, codes, or regulations that apply to the combination of products in the customer's application or use of the product.

At the customer's request, OMRON will provide applicable third party certification documents identifying ratings and limitations of use that apply to the products. This information by itself is not sufficient for a complete determination of the suitability of the products in combination with the end product, machine, system, or other application or use.

The following are some examples of applications for which particular attention must be given. This is not intended to be an exhaustive list of all possible uses of the products, nor is it intended to imply that the uses listed may be suitable for the products:

- Outdoor use, uses involving potential chemical contamination or electrical interference, or conditions or uses not described in this document.
- Nuclear energy control systems, combustion systems, railroad systems, aviation systems, medical equipment, amusement machines, vehicles, safety equipment, and installations subject to separate industry or government regulations.
- Systems, machines, and equipment that could present a risk to life or property.

Please know and observe all prohibitions of use applicable to the products.

NEVER USE THE PRODUCTS FOR AN APPLICATION INVOLVING SERIOUS RISK TO LIFE OR PROPERTY WITHOUT ENSURING THAT THE SYSTEM AS A WHOLE HAS BEEN DESIGNED TO ADDRESS THE RISKS, AND THAT THE OMRON PRODUCT IS PROPERLY RATED AND INSTALLED FOR THE INTENDED USE WITHIN THE OVERALL EQUIPMENT OR SYSTEM.

**PERFORMANCE DATA**

---

Performance data given in this document is provided as a guide for the user in determining suitability and does not constitute a warranty. It may represent the result of OMRON's test conditions, and the users must correlate it to actual application requirements. Actual performance is subject to the OMRON Warranty and Limitations of Liability.

**CHANGE IN SPECIFICATIONS**

---

Product specifications and accessories may be changed at any time based on improvements and other reasons.

It is our practice to change model numbers when published ratings or features are changed, or when significant construction changes are made. However, some specifications of the product may be changed without any notice. When in doubt, special model numbers may be assigned to fix or establish key specifications for your application on your request. Please consult with your OMRON representative at any time to confirm actual specifications of purchased products.

**DIMENSIONS AND WEIGHTS**

---

Dimensions and weights are nominal and are not to be used for manufacturing purposes, even when tolerances are shown.

**ERRORS AND OMISSIONS**

---

The information in this document has been carefully checked and is believed to be accurate; however, no responsibility is assumed for clerical, typographical, or proofreading errors, or omissions.

**PROGRAMMABLE PRODUCTS**

---

OMRON shall not be responsible for the user's programming of a programmable product, or any consequence thereof.

Cat. No. F09E-EN-01

**In the interest of product improvement, specifications are subject to change without notice.**

---

**OMRON EUROPE B.V.**

Wegalaan 67-69,  
 NL-2132 JD, Hoofddorp,  
 The Netherlands  
 Phone: +31 23 568 13 00  
 Fax: +31 23 568 13 88  
 www.industrial.omron.eu